

OPERA 2A DOUBLE SLIDER

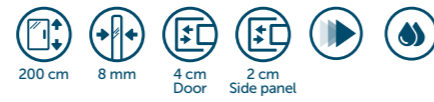

SHOWER DOOR, 2 SLIDING DOORS + 2 FIXED PANELS IN LINE
SOFT CLOSING

Dimensions				Code	Glass		Profile type		
Size	Actual dimensions	Fixed panel	Access		1	51	U	B	K
	A	F1	*		Clear	Ravenna print	White soft	Silver	Chrome

DOOR

STANDARD				
120	117 ↔ 121	31	44	OPE2A117-
130	125 ↔ 129	33	48	OPE2A125-
140	137 ↔ 141	36	54	OPE2A137-
150	145 ↔ 149	38	58	OPE2A145-
160	157 ↔ 161	41	64	OPE2A157-
170	165 ↔ 169	43	68	OPE2A165-
180	177 ↔ 181	46	74	OPE2A177-
200	197 ↔ 201	51	84	OPE2A197-
OTHER SIZES				
◇	121 ↔ 125	32	46	OPE2A121-
◇	129 ↔ 133	34	50	OPE2A129-
◇	133 ↔ 137	35	52	OPE2A133-
◇	141 ↔ 145	37	56	OPE2A141-
◇	149 ↔ 153	39	60	OPE2A149-
◇	153 ↔ 157	40	62	OPE2A153-
◇	161 ↔ 165	42	66	OPE2A161-
◇	169 ↔ 173	44	70	OPE2A169-
◇	173 ↔ 177	45	72	OPE2A173-

SIDE PANEL

STANDARD				
70	67 ↔ 69	◇	◇	OPEF67-
80	77 ↔ 79	◇	◇	OPEF77-
90	87 ↔ 89	◇	◇	OPEF87-
100	97 ↔ 99	◇	◇	OPEF97-
120	117 ↔ 119	◇	◇	OPEF117-
OTHER SIZES				
◇	69 ↔ 71	◇	◇	OPEF69-
◇	75 ↔ 77	◇	◇	OPEF75-
◇	79 ↔ 81	◇	◇	OPEF79-
◇	85 ↔ 87	◇	◇	OPEF85-
◇	89 ↔ 91	◇	◇	OPEF89-
◇	95 ↔ 97	◇	◇	OPEF95-
◇	99 ↔ 101	◇	◇	OPEF99-
◇	115 ↔ 117	◇	◇	OPEF115-

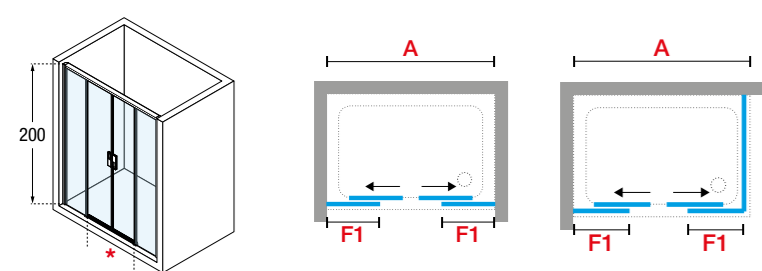

Available from October 2017
● IN STOCK UK
 (Other products) please check availability

Construction of the Code: **Code** + **Glass** + **Profile** = Final product Code



OPERA

TECHNICAL DATA

GLASS TYPES 8 MM
(European standards UNI EN 14428)

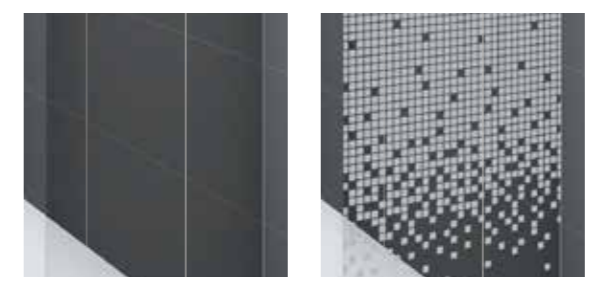

Clear
COD. 1

Ravenna print.
COD. 51

HANDLES



Chromed metal handles

PROFILE COLOURS

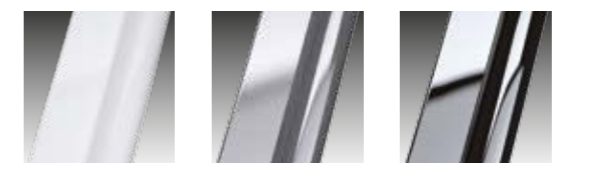

White soft
COD. U

Silver
COD. B

Chrome
COD. K

OVERALL DIMENSIONS FIXING PROFILES

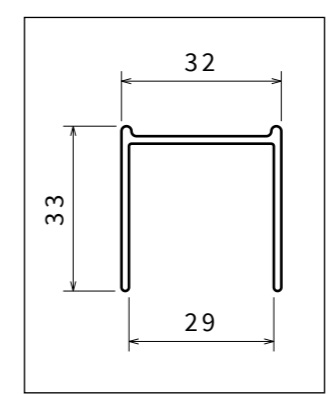

HOW TO TAKE THE MEASUREMENT

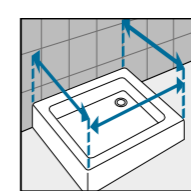
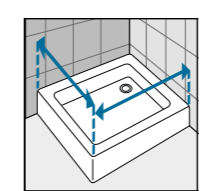

Take the measurement from wall to the external edge of the shower tray. Dimensions must be taken once the walls are finished and tiled, according to the above drawings.

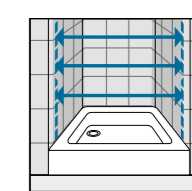

Take the measurements from wall to wall at the bottom, at the top, in the middle and use the smallest. Dimensions must be taken once the walls are finished and tiled, according to the above drawings.

OPERA 2P 2 PART SLIDER

SHOWER DOOR, 1 SLIDING DOOR + 1 FIXED PANEL IN LINE
SOFT CLOSING

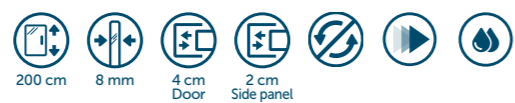

Dimensions				Code	Left	Right	Glass		Profile type		
Size	Actual dimensions	Fixed panel	Access		S-	D-	1	51	U	B	K
A	F1	*					Clear	Ravenna print	White soft	Silver	Chrome

DOOR

STANDARD											
100	97 ↔ 101	49	39	OPE2P97	S-	D-					
120	117 ↔ 121	59	49	OPE2P117	S-	D-	●				
140	137 ↔ 141	69	59	OPE2P137	S-	D-	●				
150	147 ↔ 151	74	64	OPE2P147	S-	D-					
160	157 ↔ 161	79	69	OPE2P157	S-	D-					
170	167 ↔ 171	84	74	OPE2P167	S-	D-					
180	177 ↔ 181	89	79	OPE2P177	S-	D-					

OTHER SIZES											
◇	107 ↔ 111	54	44	OPE2P107	S-	D-					

SIDE PANEL

STANDARD											
70	67 ↔ 69	◇	◇	OPEF67-	◇	◇					
80	77 ↔ 79	◇	◇	OPEF77-	◇	◇	●				
90	87 ↔ 89	◇	◇	OPEF87-	◇	◇	●				
100	97 ↔ 99	◇	◇	OPEF97-	◇	◇	●				
120	117 ↔ 119	◇	◇	OPEF117-	◇	◇					

OTHER SIZES											
◇	69 ↔ 71	◇	◇	OPEF69-	◇	◇					
◇	75 ↔ 77	◇	◇	OPEF75-	◇	◇					
◇	79 ↔ 81	◇	◇	OPEF79-	◇	◇					
◇	85 ↔ 87	◇	◇	OPEF85-	◇	◇					
◇	89 ↔ 91	◇	◇	OPEF89-	◇	◇					
◇	95 ↔ 97	◇	◇	OPEF95-	◇	◇					
◇	99 ↔ 101	◇	◇	OPEF99-	◇	◇					
◇	115 ↔ 117	◇	◇	OPEF115-	◇	◇					

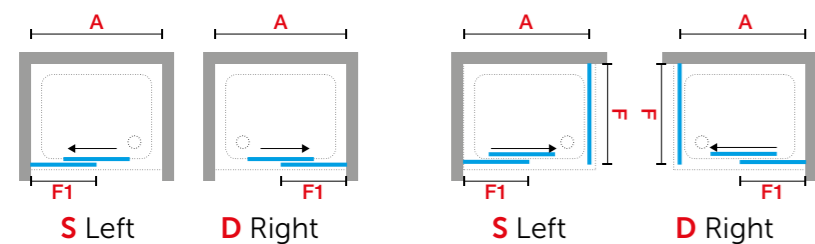
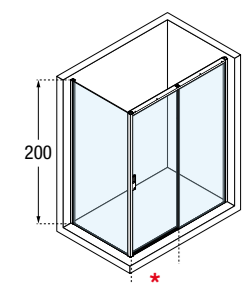

Available from October 2017

● IN STOCK UK
(Other products) please check availability

Construction of the Code: Code + Left/Right + Glass + Profile = Final product Code



TECHNICAL DATA

GLASS TYPES 8 MM
(European standards UNI EN 14428)



Clear
COD. 1

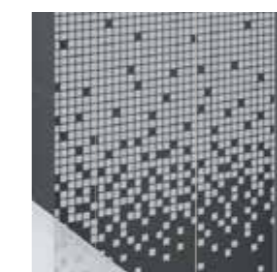

Ravenna print.
COD. 51

HANDLES



Chromed metal handles

PROFILE COLOURS



White soft
COD. U



Silver
COD. B



Chrome
COD. K

OVERALL DIMENSIONS FIXING PROFILES

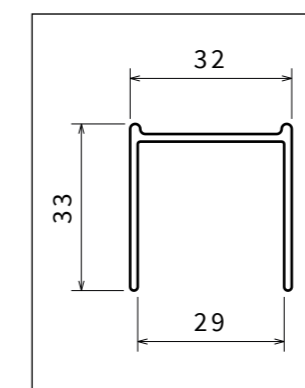

HOW TO TAKE THE MEASUREMENT

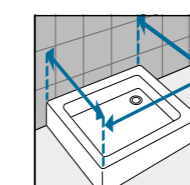
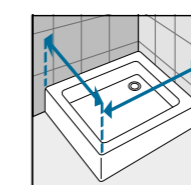

Take the measurement from wall to the external edge of the shower tray. Dimensions must be taken once the walls are finished and tiled, according to the above drawings.

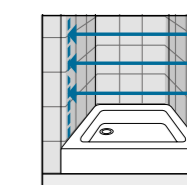

Take the measurements from wall to wall at the bottom, at the top, in the middle and use the smallest. Dimensions must be taken once the walls are finished and tiled, according to the above drawings.

OPERA 2PH 2 PART SLIDER



SHOWER DOOR, 1 SLIDING DOOR + 1 FIXED PANEL IN LINE
SOFT CLOSING

Dimensions				Code	Left	Right	Glass		Profile type		
Size	Actual dimensions	Fixed panel	Access		S-	D-	1	51	U	B	K
	A	F1	*				Clear	Ravenna print	White soft	Silver	Chrome
STANDARD											
90	87 ↔ 90	46	35	OPE2PH87	S-	D-					
100	97 ↔ 100	51	40	OPE2PH97	S-	D-					
120	117 ↔ 120	61	50	OPE2PH117	S-	D-					
140	137 ↔ 140	71	60	OPE2PH137	S-	D-					
150	147 ↔ 150	76	65	OPE2PH147	S-	D-					
160	157 ↔ 160	81	70	OPE2PH157	S-	D-					
170	167 ↔ 170	86	75	OPE2PH167	S-	D-					
180	177 ↔ 180	91	80	OPE2PH177	S-	D-					
200	197 ↔ 200	101	90	OPE2PH197	S-	D-					
OTHER SIZES											
◇	90 ↔ 93	48	37	OPE2PH90	S-	D-					
◇	100 ↔ 103	53	42	OPE2PH100	S-	D-					
◇	120 ↔ 123	63	52	OPE2PH120	S-	D-					
◇	140 ↔ 143	73	62	OPE2PH140	S-	D-					
◇	150 ↔ 153	78	67	OPE2PH150	S-	D-					
◇	160 ↔ 163	83	72	OPE2PH160	S-	D-					
◇	170 ↔ 173	88	77	OPE2PH170	S-	D-					
◇	180 ↔ 183	93	82	OPE2PH180	S-	D-					
◇	200 ↔ 203	103	92	OPE2PH200	S-	D-					

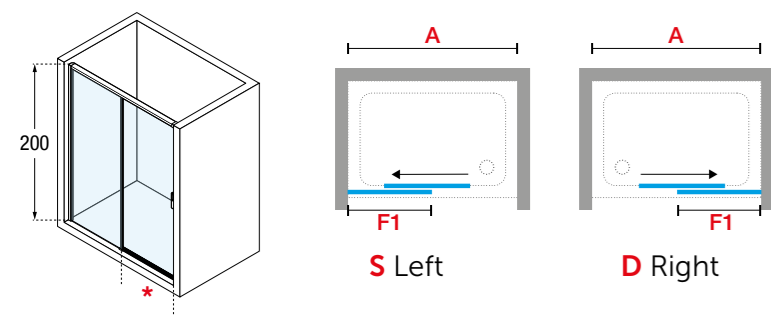

Available from October 2017

● IN STOCK UK

(Other products) please check availability

Construction of the Code: Code + Left/Right + Glass + Profile = Final product Code



OPERA

TECHNICAL DATA

GLASS TYPES 8 MM
(European standards UNI EN 14428)



Clear
COD. 1

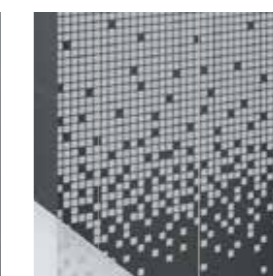

Ravenna print.
COD. 51

HANDLES



Chromed metal handles

PROFILE COLOURS



White soft
COD. U



Silver
COD. B



Chrome
COD. K

OVERALL DIMENSIONS FIXING PROFILES

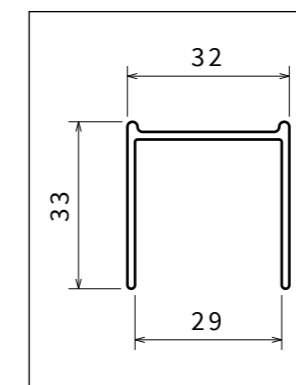

HOW TO TAKE THE MEASUREMENT

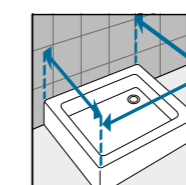
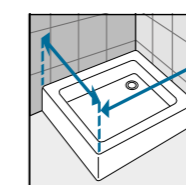

Take the measurement from wall to the external edge of the shower tray. Dimensions must be taken once the walls are finished and tiled, according to the above drawings.

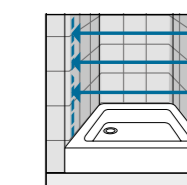

Take the measurements from wall to wall at the bottom, at the top, in the middle and use the smallest. Dimensions must be taken once the walls are finished and tiled, according to the above drawings.

OPERA A CORNER ENTRY SLIDER



CORNER ENTRY SHOWER ENCLOSURE, 2 SLIDING DOORS + 2 FIXED PANELS
SOFT CLOSING - TO COMPLETE A CORNER ENTRY, ORDER 2 SIDES

Dimensions				Code	Left	Right	Glass		Profile type		
Size	Actual dimensions	Fixed panel	Access				1	51	U	B	K
	A	F1	*				Clear	Ravenna print	White soft	Silver	Chrome
STANDARD											
70	67 ↔ 69	34	35	OPEA67L	S-	D-					
80	77 ↔ 79	39	42	OPEA77L	S-	D-					
90	87 ↔ 89	44	49	OPEA87L	S-	D-					
100	97 ↔ 99	49	56	OPEA97L	S-	D-					
120	117 ↔ 119	59	70	OPEA117L	S-	D-					
OTHER SIZES											
◇	69 ↔ 71	35	36	OPEA69L	S-	D-					
◇	75 ↔ 77	38	41	OPEA75L	S-	D-					
◇	79 ↔ 81	40	43	OPEA79L	S-	D-					
◇	85 ↔ 87	43	48	OPEA85L	S-	D-					
◇	89 ↔ 91	45	51	OPEA89L	S-	D-					
◇	95 ↔ 97	48	55	OPEA95L	S-	D-					
◇	99 ↔ 101	50	58	OPEA99L	S-	D-					
◇	115 ↔ 117	58	69	OPEA115L	S-	D-					
◇	119 ↔ 121	60	72	OPEA119L	S-	D-					

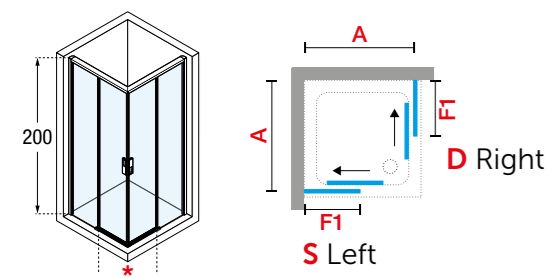

Available from October 2017

● IN STOCK UK

(Other products) please check availability

Construction of the Code: Code + Left/Right + Glass + Profile = Final product Code



TECHNICAL DATA

GLASS TYPES 8 MM
(European standards UNI EN 14428)



Clear
COD. 1

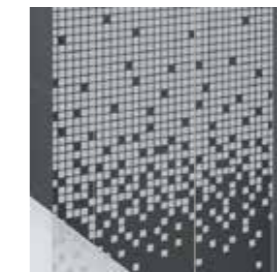

Ravenna print.
COD. 51

HANDLES



Chromed metal handles

PROFILE COLOURS



White soft
COD. U



Silver
COD. B



Chrome
COD. K

OVERALL DIMENSIONS FIXING PROFILES

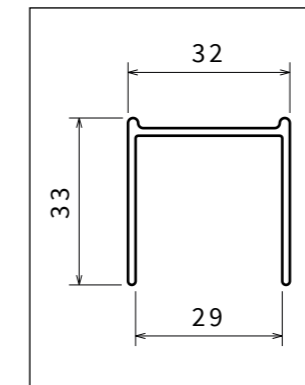

HOW TO TAKE THE MEASUREMENT

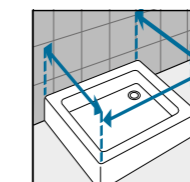
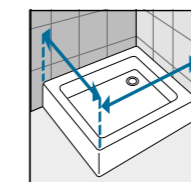

Take the measurement from wall to the external edge of the shower tray. Dimensions must be taken once the walls are finished and tiled, according to the above drawings.

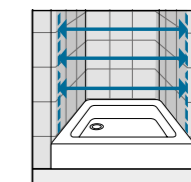

Take the measurements from wall to wall at the bottom, at the top, in the middle and use the smallest. Dimensions must be taken once the walls are finished and tiled, according to the above drawings.

OPERA PH+FH

CORNER SOLUTION, 1 SLIDING DOOR + 1 FIXED PANEL IN LINE + 1 SIDE PANEL



Dimensions				Code	Right	Left	Glass		Profile			
Size	Actual size	Fixed panel	Access		D-	S-	1	51	U	B	K	H
A		F1	*			Clear Ravenna print		Matt White	Silver	Chrome	Matt Black	
DOOR												
100	97↔99	48,5	37	OPEPH97	D-	S-						
100	99↔101	49,5	38	OPEPH99	D-	S-						
-	105↔107	52,5	41	OPEPH105	D-	S-						
-	107↔109	53,5	42	OPEPH107	D-	S-						
-	109↔111	54,5	43	OPEPH109	D-	S-						
-	115↔117	57,5	46	OPEPH115	D-	S-						
120	117↔119	58,5	47	OPEPH117	D-	S-						
-	119↔121	59,5	48	OPEPH119	D-	S-						
-	125↔127	62,5	51	OPEPH125	D-	S-						
130	127↔129	63,5	52	OPEPH127	D-	S-						
-	129↔131	64,5	53	OPEPH129	D-	S-						
-	135↔137	67,5	56	OPEPH135	D-	S-						
140	137↔139	68,5	57	OPEPH137	D-	S-						
-	139↔141	69,5	58	OPEPH139	D-	S-						
-	142↔144	71	59,5	OPEPH142	D-	S-						
-	145↔147	72,5	61	OPEPH145	D-	S-						
150	147↔149	73,5	62	OPEPH147	D-	S-						
-	149↔151	74,5	63	OPEPH149	D-	S-						
-	152↔154	76	64,5	OPEPH152	D-	S-						
-	155↔157	77,5	66	OPEPH155	D-	S-						
160	157↔159	78,5	67	OPEPH157	D-	S-						
-	159↔161	79,5	68	OPEPH159	D-	S-						
-	162↔164	81	69,5	OPEPH162	D-	S-						
-	165↔167	82,5	71	OPEPH165	D-	S-						
170	167↔169	83,5	72	OPEPH167	D-	S-						
-	169↔171	84,5	73	OPEPH169	D-	S-						
-	175↔177	87,5	76	OPEPH175	D-	S-						
180	177↔179	88,5	77	OPEPH177	D-	S-						
-	179↔181	89,5	78	OPEPH179	D-	S-						
-	195↔197	97,5	86	OPEPH195	D-	S-						
200	197↔199	98,5	87	OPEPH197	D-	S-						
-	199↔201	99,5	88	OPEPH199	D-	S-						

SIDE PANEL												
Size	Actual size	Fixed panel	Access	Code	Right	Left	Glass		Profile			
A		F1	*		D-	S-	1	51	U	B	K	H
70	67↔69	-	-	OPEFH67	D-	S-						
-	69↔71	-	-	OPEFH69	D-	S-						
-	73↔75	-	-	OPEFH73	D-	S-						
-	75↔77	-	-	OPEFH75	D-	S-						
80	77↔79	-	-	OPEFH77	D-	S-						
-	79↔81	-	-	OPEFH79	D-	S-						
-	85↔87	-	-	OPEFH85	D-	S-						
90	87↔89	-	-	OPEFH87	D-	S-						
-	89↔91	-	-	OPEFH89	D-	S-						
-	95↔97	-	-	OPEFH95	D-	S-						
100	97↔99	-	-	OPEFH97	D-	S-						
-	99↔101	-	-	OPEFH99	D-	S-						
-	105↔107	-	-	OPEFH105	D-	S-						
-	107↔109	-	-	OPEFH107	D-	S-						
-	115↔117	-	-	OPEFH115	D-	S-						
120	117↔119	-	-	OPEFH117	D-	S-						
-	119↔121	-	-	OPEFH119	D-	S-						

H = 200
L 67↔119
SPECIAL OPEFHSP

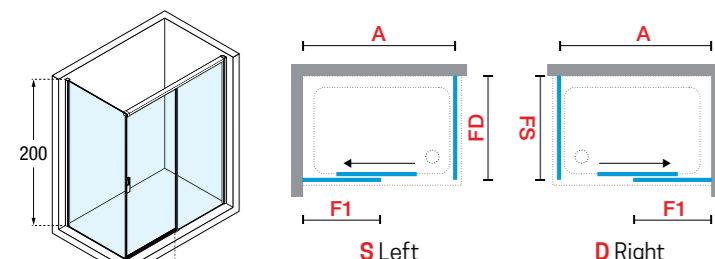

Construction of the Code: **Code** + **Left / Right** + **Glass** + **Profile** = Final product Code

IN STOCK UK
(Other products)
Please check availability



TECHNICAL DATA

PROFILE COLOURS

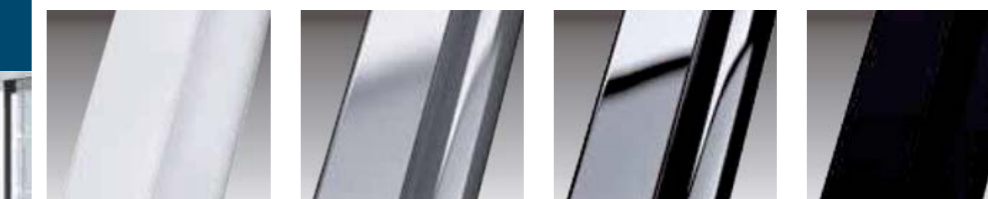

Matt White code U Silver code B Chrome code K ECO PVD CHROME Matt Black code H

GLASS TYPE 8 mm (European Standards UNI EN 14428)



Clear cod. 1

PRINTING

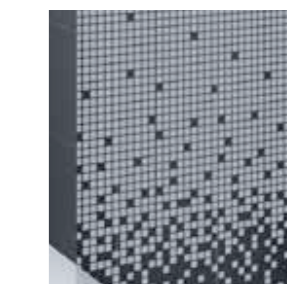

Ravenna cod. 51

HANDLES



Metal handle white, black or chrome

OVERALL DIMENSIONS FIXING PROFILES

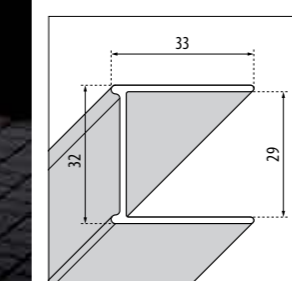

WALL for Opera PH - 2P - A - 2PH

Height	Profile	Code
1999	White	P01BXMOST-U
	Silver	P01BXMOST-B
	Chrome	P01BXMOST-K
	Black	P01BXMOST-H

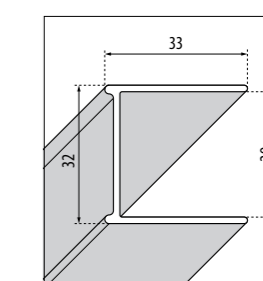

WALL for Opera FH

Height	Profile	Code
2002	White	P01BXFHST-U
	Silver	P01BXFHST-B
	Chrome	P01BXFHST-K
	Black	P01BXMOST-H

HOW TO TAKE THE MEASUREMENTS

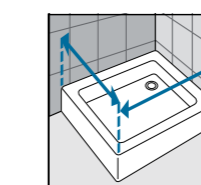

Take the measurements from wall to the external edge of the shower tray. Dimensions must be taken once the walls are finished and tiled, according to the above drawings.

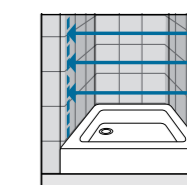

Take the measurements from wall to wall at the bottom, at the top, in the middle and use the smallest. Dimensions must be taken once the walls are finished and tiled, according to the above drawings.

GLASS TYPE



Clear code 1 Ravenna Print code 51

PROFILE COLOURS



Matt White code U Silver code B Chrome code K Matt Black code H