

# YOUNG PLUS 1B

HINGED SHOWER DOOR FOR RECESS INSTALLATION



Dimensions				Code	Glass		Profile	
Tray Size	Actual size	Access	Door projection		1	44	K	H
	<b>A1</b>	<b>*</b>	<b>B</b>		Clear	Band satin	Chrome	Matt Black
80	77↔81	68	69	<b>YPLUS1B77-</b>	●			
-	82↔86	73	74	<b>YPLUS1B82-</b>				
90	87↔91	78	79	<b>YPLUS1B87-</b>	●			
-	92↔96	83	84	<b>YPLUS1B92-</b>				
100	97↔101	88	89	<b>YPLUS1B97-</b>	●			

## OPTIONAL

**LOWER DOOR GASKET**  
WHEN INSTALLED WITHOUT THE SUPPLIED THRESHOLD TRIM ON A TILED OR VINYL FLOOR

Code: **R55SPB8M01-TR**

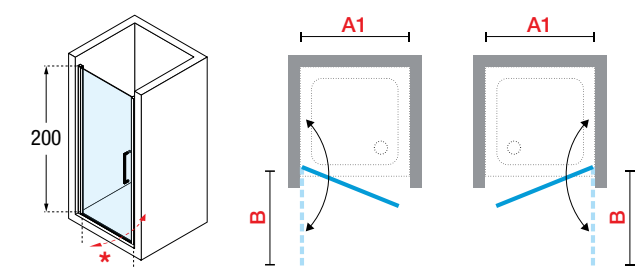

● **IN STOCK UK**  
(Other products) please check availability

Construction of the Code: **Code** + **Glass** + **Profile** = Final product Code

**A** Installation on shower tray  
**G** Installation on floor

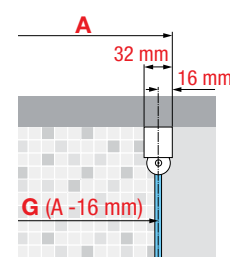

## GLASS TYPE

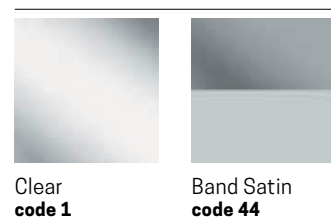

## PROFILE COLOURS



## TECHNICAL DATA

### PROFILE COLOURS



### GLASS TYPES 8 mm (European Standards UNI EN 14428)

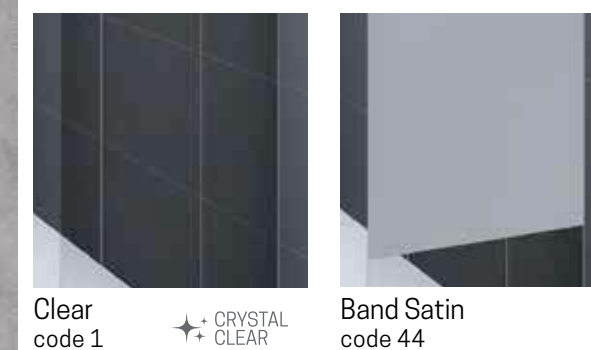

### OVERALL DIMENSIONS FIXING PROFILES

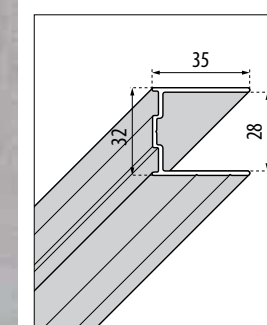

#### STANDARD PROFILE

Height	Profile	Code
1984	Chrome	<b>P01BNMOBST-K</b>
	Black	<b>P01BNMOBST-H</b>
2000	Chrome	<b>P01BNMOAST-K</b>
	Black	<b>P01BNMOAST-H</b>

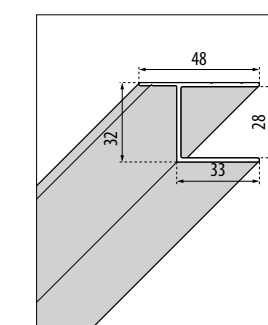

#### LATERAL WALL FIXING

Height	Profile	Code
1984	Chrome	<b>P01Y2MOBSTL-K</b>
	Black	<b>P01Y2MOBSTL-H</b>
2000	Chrome	<b>P01Y2MOASTL-K</b>
	Black	<b>P01Y2MOASTL-H</b>

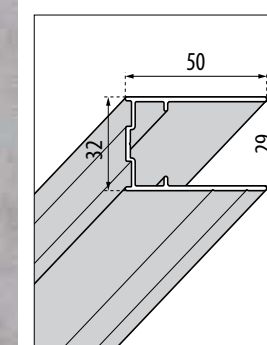

#### EXTENSION

Deeper wall profile (+ 15 mm adjustability)

Height	Profile	Code
1984	Chrome	<b>P05Y2ST-K</b>
	Black	<b>P05Y2ST-H</b>
2000	Chrome	<b>P05Y2ST2-K</b>
	Black	<b>P05Y2ST2-H</b>

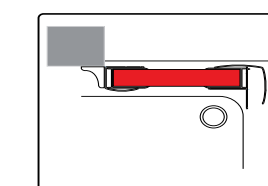

### HOW TO TAKE THE MEASUREMENTS

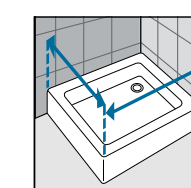

Take the measurements from wall to the external edge of the shower tray. Dimensions must be taken once the walls are finished and tiled, according to the above drawings.

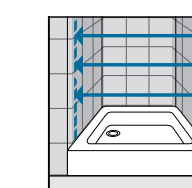

Take the measurements from wall to wall at the bottom, at the top, in the middle and use the smallest. Dimensions must be taken once the walls are finished and tiled, according to the above drawings.

# YOUNG PLUS 2G

CORNER ENTRY ENCLOSURE, 2 HINGED DOORS



Shower tray Size	Dimensions			Product Code	Glass		Profile	
	Actual size	Access	Door projection		1	44	K	H
-	<b>A</b>	<b>*</b>	<b>B</b>		Clear	Band satin	Chrome	Matt Black
-	76↔78	96	68	<b>YPLUS2G76L-</b>	●			
80	77↔79	97	69	<b>YPLUS2G77L-</b>	●			
-	79↔81	100	71	<b>YPLUS2G79L-</b>				
-	81↔83	103	73	<b>YPLUS2G81L-</b>				
-	83↔85	106	75	<b>YPLUS2G83L-</b>				
-	85↔87	108	77	<b>YPLUS2G85L-</b>				
90	87↔89	111	79	<b>YPLUS2G87L-</b>	●			
-	89↔91	114	81	<b>YPLUS2G89L-</b>				
-	91↔93	117	83	<b>YPLUS2G91L-</b>				
-	93↔95	120	85	<b>YPLUS2G93L-</b>				
-	95↔97	123	87	<b>YPLUS2G95L-</b>				
100	97↔99	125	89	<b>YPLUS2G97L-</b>	●			
-	99↔101	128	91	<b>YPLUS2G99L-</b>				
-	101↔103	131	93	<b>YPLUS2G101L-</b>				
-	103↔105	134	95	<b>YPLUS2G103L-</b>				

TO COMPLETE A CORNER ENTRY, ORDER 2 SIDES

## OPTIONAL

**LOWER DOOR GASKET**  
WHEN INSTALLED WITHOUT THE SUPPLIED THRESHOLD TRIM ON A TILED OR VINYL FLOOR

Code: **R55SPB8A01-TR**

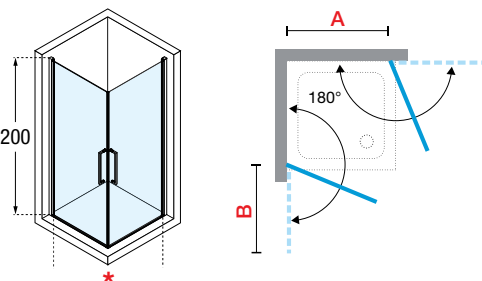

● **IN STOCK UK**  
(Other products) please check availability

Construction of the Code: **Code** + **Glass** + **Profile** = Final product Code

**A** Installation on shower tray  
**G** Installation on floor

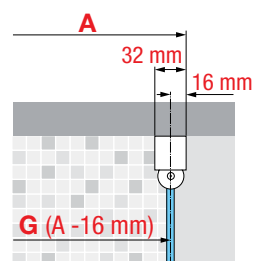

## GLASS TYPE

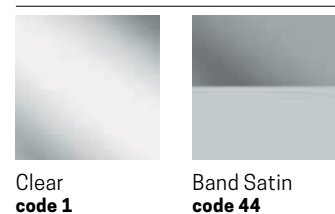

## PROFILE COLOURS



## TECHNICAL DATA

### PROFILE COLOURS



### GLASS TYPES 8 mm (European Standards UNI EN 14428)

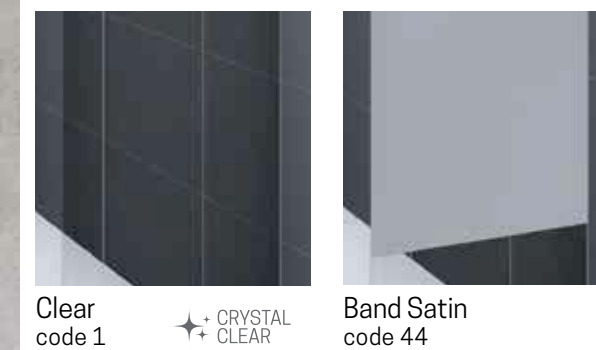

### OVERALL DIMENSIONS FIXING PROFILES

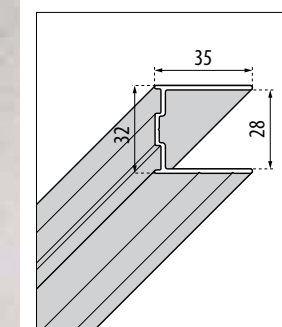

#### STANDARD PROFILE

Height	Profile	Code
1984	Chrome	<b>P01BNMOBST-K</b>
	Black	<b>P01BNMOBST-H</b>
2000	Chrome	<b>P01BNMOAST-K</b>
	Black	<b>P01BNMOAST-H</b>

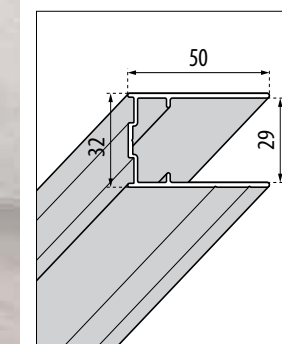

#### EXTENSION

Deeper wall profile (+ 15 mm adjustability)

Height	Profile	Code
1984	Chrome	<b>P05Y2ST-K</b>
	Black	<b>P05Y2ST-H</b>
2000	Chrome	<b>P05Y2ST2-K</b>
	Black	<b>P05Y2ST2-H</b>

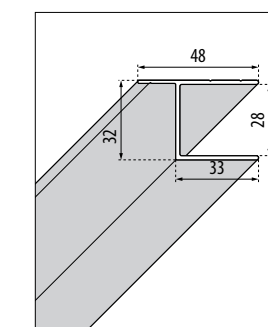

#### LATERAL WALL FIXING

Height	Profile	Code
1984	Chrome	<b>P01Y2MOBSTL-K</b>
	Black	<b>P01Y2MOBSTL-H</b>
2000	Chrome	<b>P01Y2MOASTL-K</b>
	Black	<b>P01Y2MOASTL-H</b>

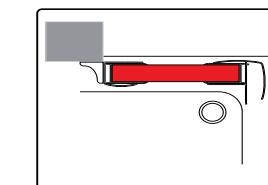

### HOW TO TAKE THE MEASUREMENTS

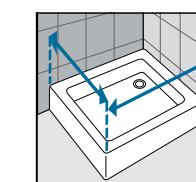

Take the measurements from wall to the external edge of the shower tray. Dimensions must be taken once the walls are finished and tiled, according to the above drawings.

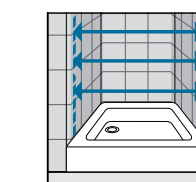

Take the measurements from wall to wall at the bottom, at the top, in the middle and use the smallest. Dimensions must be taken once the walls are finished and tiled, according to the above drawings.



# YOUNG PLUS G+F



Dimensions					Code	Right	Left	Glass		Profile	
Tray Size	Actual size	Fix panel in line	Access	Door projection		D-	S-	1	44	K	H
A	F1	*	B					Clear	Band satin	Chrome	Matt Black
<b>DOOR REVERSIBLE</b>											
100	97↔101	33	58	59	YPLUSGFL97-						
110	107↔111	33	68	69	YPLUSGFL107-			●			
-	114↔118	40	68	69	YPLUSGFL114-			●			
120	117↔121	43	68	69	YPLUSGFL117-			●			
-	134↔138	50	78	79	YPLUSGFL134-			●			
140	137↔141	53	78	79	YPLUSGFL137-			●			
150	147↔151	63	78	79	YPLUSGFL147-			●			
-	154↔158	70	78	79	YPLUSGFL154-			●			
160	157↔161	63	88	89	YPLUSGFL157-			●			
-	164↔168	70	88	89	YPLUSGFL164-			●			
170	167↔171	73	88	89	YPLUSGFL167-			●			
180	177↔181	83	88	89	YPLUSGFL177-			●			

<b>DOOR NOT REVERSIBLE WITH SATIN BAND</b>											
								1	44	K	H
110	107↔111	33	68	69	YPLUSGFL107	D-	S-	-			
-	114↔118	40	68	69	YPLUSGFL114	D-	S-	-			
120	117↔121	43	68	69	YPLUSGFL117	D-	S-	-			
-	134↔138	50	78	79	YPLUSGFL134	D-	S-	-			
140	137↔141	53	78	79	YPLUSGFL137	D-	S-	-			
150	147↔151	63	78	79	YPLUSGFL147	D-	S-	-			
-	154↔158	70	78	79	YPLUSGFL154	D-	S-	-			
160	157↔161	63	88	89	YPLUSGFL157	D-	S-	-			
-	164↔168	70	88	89	YPLUSGFL164	D-	S-	-			
170	167↔171	73	88	89	YPLUSGFL167	D-	S-	-			
180	177↔181	83	88	89	YPLUSGFL177	D-	S-	-			

## OPTIONAL

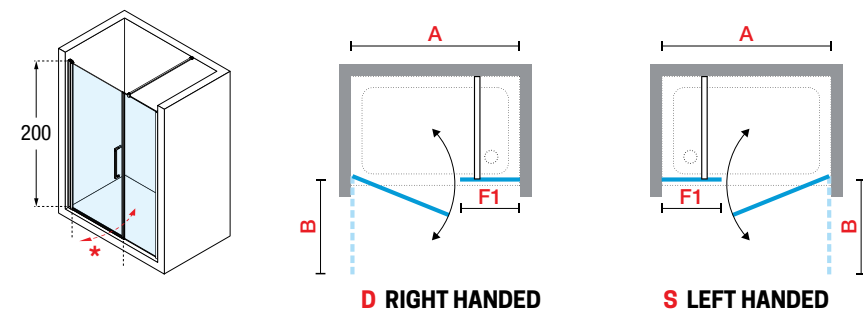

**A** Installation on shower tray  
**G** Installation on floor

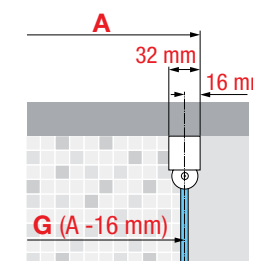

● **IN STOCK UK**  
(Other products) please check availability

**ONLY HANDED WITH SATIN BAND**

Construction of the Code: **Code** + **Left / Right** + **Glass** + **Profile** = Final product Code



## TECHNICAL DATA

### PROFILE COLOURS

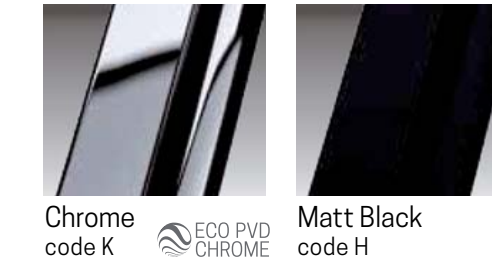

### GLASS TYPES 8 mm (European Standards UNI EN 14428)



### OVERALL DIMENSIONS FIXING PROFILES

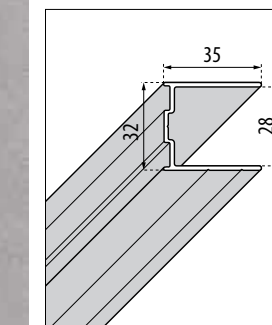

#### STANDARD PROFILE

Height	Profile	Code
1984	Chrome	P01BNMOBST-K
	Black	P01BNMOBST-H
2000	Chrome	P01BNMOAST-K
	Black	P01BNMOAST-H

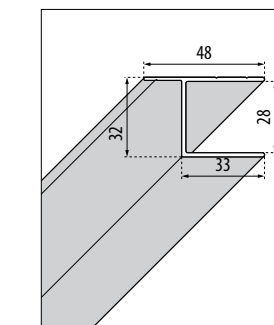

#### LATERAL WALL FIXING

Height	Profile	Code
1984	Chrome	P01Y2MOBSTL-K
	Black	P01Y2MOBSTL-H
2000	Chrome	P01Y2MOASTL-K
	Black	P01Y2MOASTL-H

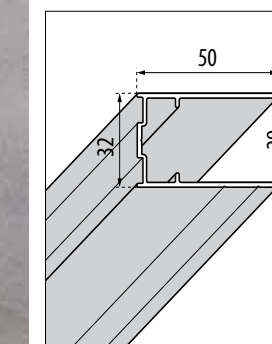

#### EXTENSION

Deeper wall profile (+ 15 mm adjustability)

Height	Profile	Code
1984	Chrome	P05Y2ST-K
	Black	P05Y2ST-H
2000	Chrome	P05Y2ST2-K
	Black	P05Y2ST2-H

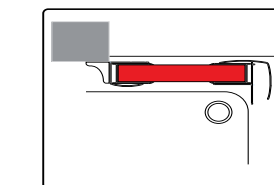

### HOW TO TAKE THE MEASUREMENTS

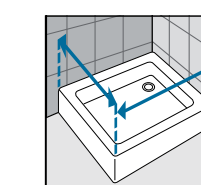

Take the measurements from wall to the external edge of the shower tray. Dimensions must be taken once the walls are finished and tiled, according to the above drawings.

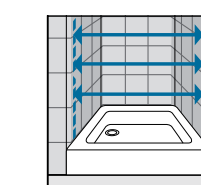

Take the measurements from wall to wall at the bottom, at the top, in the middle and use the smallest. Dimensions must be taken once the walls are finished and tiled, according to the above drawings.

### GLASS TYPE

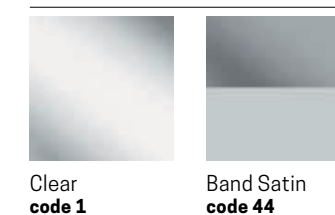

### PROFILE COLOURS



# YOUNG PLUS G+F IN LINE



SHOWER DOOR, 1 HINGED DOOR + 1 FIXED PANEL IN LINE  
INSTALLED IN A NICHE

Dimensions					Code	Right	Left	Glass		Profile	
Tray Size	Actual size	Fix panel in line	Access	Door projection		D-	S-	1	44	K	H
A	F1	*	B					Clear	Band satin	Chrome	Matt Black

DOOR REVERSIBLE											
100	97↔101	33	58	59	YPLUSGFL97-						
110	107↔111	33	68	69	YPLUSGFL107-			●			
-	114↔118	40	68	69	YPLUSGFL114-			●			
120	117↔121	43	68	69	YPLUSGFL117-			●			
-	134↔138	50	78	79	YPLUSGFL134-						
140	137↔141	53	78	79	YPLUSGFL137-			●			
150	147↔151	63	78	79	YPLUSGFL147-			●			
-	154↔158	70	78	79	YPLUSGFL154-						
160	157↔161	63	88	89	YPLUSGFL157-			●			
-	164↔168	70	88	89	YPLUSGFL164-						
170	167↔171	73	88	89	YPLUSGFL167-			●			
180	177↔181	83	88	89	YPLUSGFL177-						

DOOR NOT REVERSIBLE WITH SATIN BAND											
								1	44	K	H
100	97↔101	33	58	59	YPLUSGFL97-	D-	S-				
110	107↔111	33	68	69	YPLUSGFL107	D-	S-				
-	114↔118	40	68	69	YPLUSGFL114	D-	S-				
120	117↔121	43	68	69	YPLUSGFL117	D-	S-				
-	134↔138	50	78	79	YPLUSGFL134	D-	S-				
140	137↔141	53	78	79	YPLUSGFL137	D-	S-				
150	147↔151	63	78	79	YPLUSGFL147	D-	S-				
-	154↔158	70	78	79	YPLUSGFL154	D-	S-				
160	157↔161	63	88	89	YPLUSGFL157	D-	S-				
-	164↔168	70	88	89	YPLUSGFL164	D-	S-				
170	167↔171	73	88	89	YPLUSGFL167	D-	S-				
180	177↔181	83	88	89	YPLUSGFL177	D-	S-				

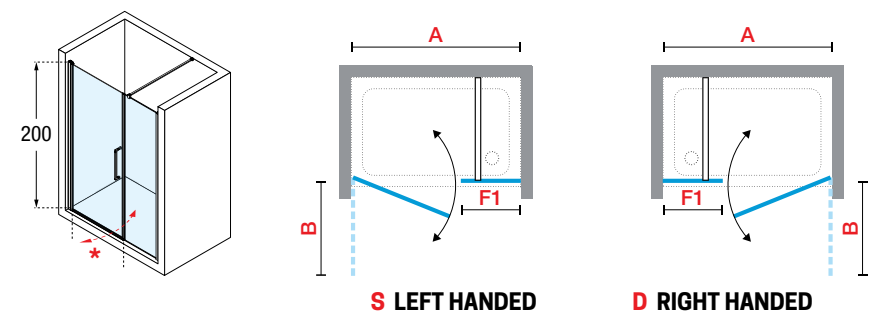

### OPTIONAL

**LOWER DOOR GASKET**  
WHEN INSTALLED WITHOUT THE SUPPLIED THRESHOLD TRIM ON A TILED OR VINYL FLOOR

Code	Price
R55SPB8A01-TR	

ONLY HANDED WITH SATIN BAND

Construction of the Code: **Code** + **Left / Right** + **Glass** + **Profile** = Final product Code

● **IN STOCK UK**  
(Other products) Please check availability



YOUNG PLUS

## TECHNICAL DATA

### PROFILE COLOURS

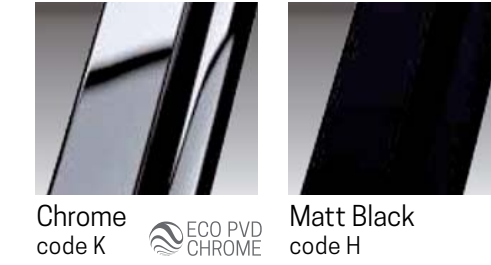

Chrome code K Matt Black code H

### GLASS TYPES 8 mm (European Standards UNI EN 14428)

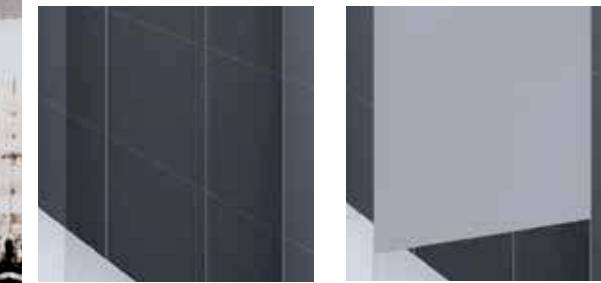

Clear code 1 Band Satin code 44

### OVERALL DIMENSIONS FIXING PROFILES

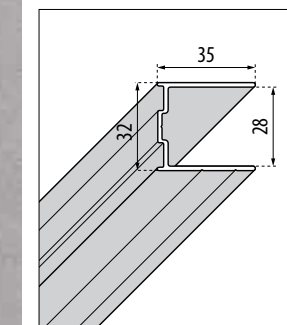

#### STANDARD PROFILE

Height	Profile	Code
1984	Chrome	P01BNMOBST-K
	Black	P01BNMOBST-H
2000	Chrome	P01BNMOAST-K
	Black	P01BNMOAST-H

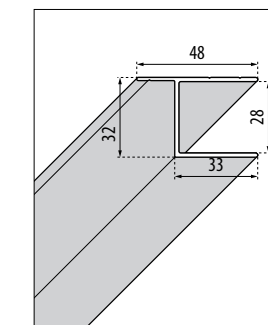

#### LATERAL WALL FIXING

Height	Profile	Code
1984	Chrome	P01Y2MOBSTL-K
	Black	P01Y2MOBSTL-H
2000	Chrome	P01Y2MOASTL-K
	Black	P01Y2MOASTL-H

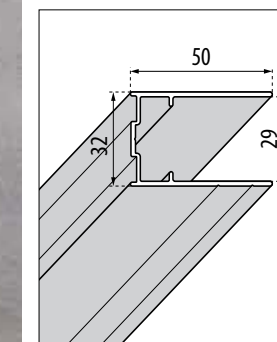

#### EXTENSION

Deeper wall profile (+ 15 mm adjustability)

Height	Profile	Code
1984	Chrome	P05Y2ST-K
	Black	P05Y2ST-H
2000	Chrome	P05Y2ST2-K
	Black	P05Y2ST2-H

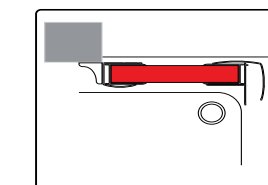

### HOW TO TAKE THE MEASUREMENTS

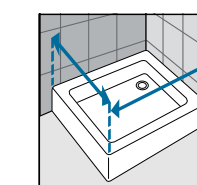

Take the measurements from wall to the external edge of the shower tray. Dimensions must be taken once the walls are finished and tiled, according to the above drawings.

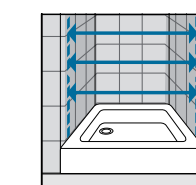

Take the measurements from wall to wall at the bottom, at the top, in the middle and use the smallest. Dimensions must be taken once the walls are finished and tiled, according to the above drawings.

### GLASS TYPE

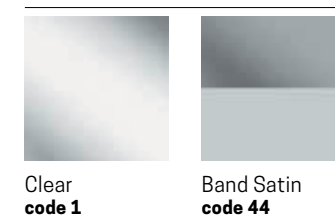

### PROFILE COLOURS

